

JEOL

JCM-6000

Benchtop SEM

NeoScope™

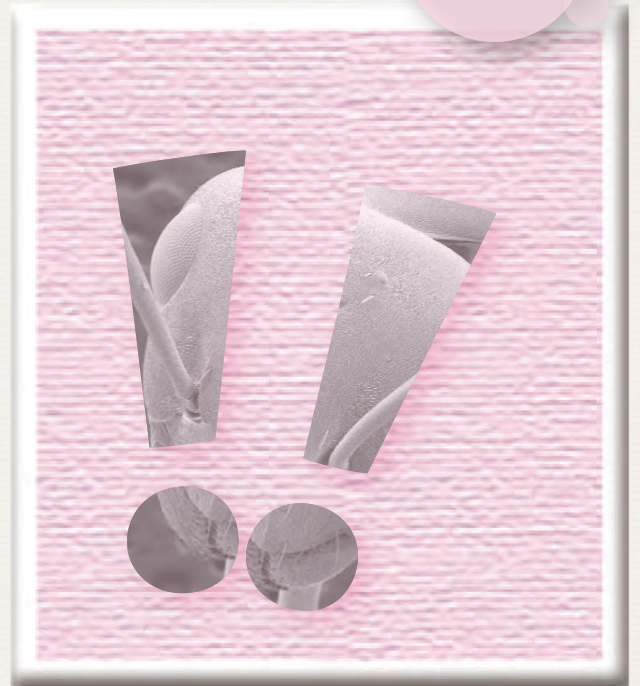

The Most Advanced Benchtop SEM

NeoScope™ JCM-6000

High Vacuum or Low Vacuum mode selectable
Sample imaging at various angles using a tilt
rotation motorized specimen holder*

*Optional accessory

Advanced capabilities

Intuitive operation

Utmost ease of operation through a touch
panel system with intuitive GUI

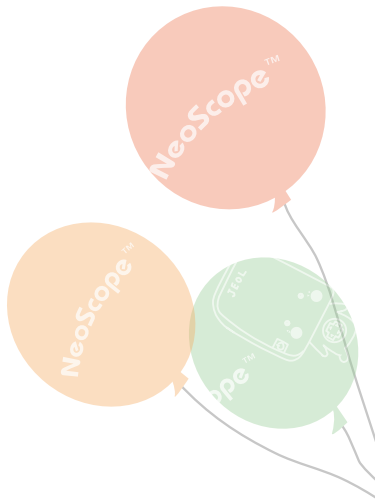



Easy maintenance

Cartridge filament integrating wehnelt for easy exchange
Auto gun alignment capability

Quick response

Speedy system startup
A single touch to select
High Vacuum or Low Vacuum mode

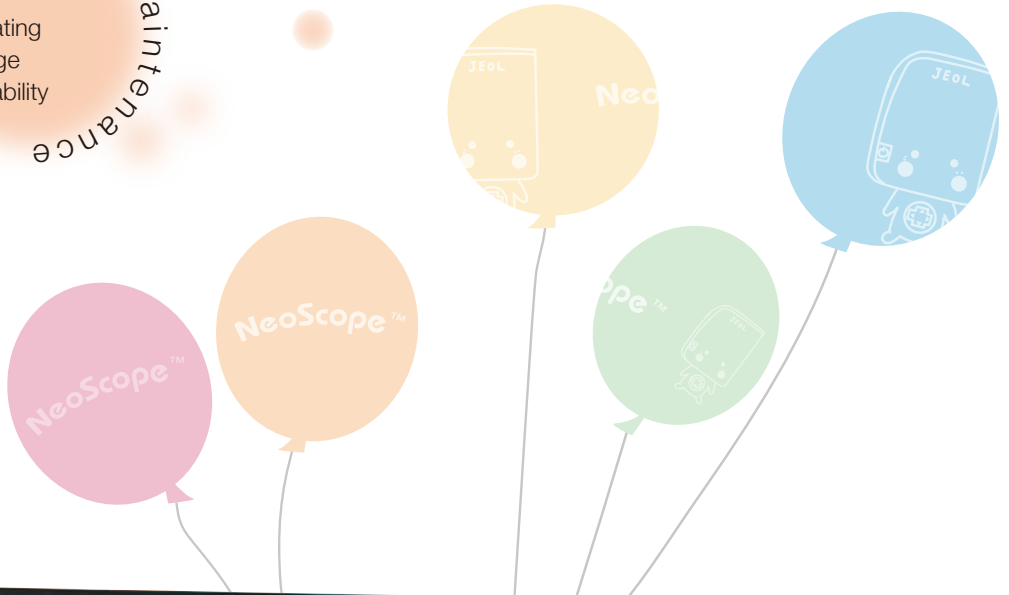

Sample: Compound eye of an ant

Natural & Humanistic

Intuitive operation



Sample: Iron rust

Touch panel

JEOL's renowned image quality can be achieved with the utmost ease. A touch panel system with intuitive GUI will guide the operator through the imaging process with the level of ease equal to a smartphone.

Automated functions

Auto controls include alignment, focus, stigmator, contrast/brightness, and Full Auto. A single touch of Full Auto will initiate the entire imaging process to present an image instantly.



Manual control

An item touched and selected will turn green.

Hard, continued pressing of the buttons for coarse control. Light, intermittent tapping for fine control.

These control buttons combines the ease of operation from the touch panel and the familiar feel of the knobs.

Image search/display

The Display image button is used to search a library of images for a specific image. Checking the Display image button after selecting a desired image will present a magnified view of the image for closer examination.

Minimum magnification image

Checking the Low Mag Image will allow the operator to view an image acquired at the lowest magnification immediately after the evacuation sequence was completed. This is a useful feature when examining the positioning of the sample.

Preset magnification

Up to 6 magnifications are presettable. Programming frequently used magnifications will increase operating efficiency. One of the buttons can be used to preset the current magnification.

Advanced capabilities

01

Observe

A single touch can switch the mode between High Vacuum and Low Vacuum, allowing the operator to acquire a variety of images.

High vacuum mode

Secondary electron image in the High Vacuum mode can bring out clear images of samples that require high magnification image and samples with an uneven surface. Comparing SEI images with BEI images allows for closer examination of the surface structure.

The image mode may also be switched to backscattered electron image to examine compositional differences.

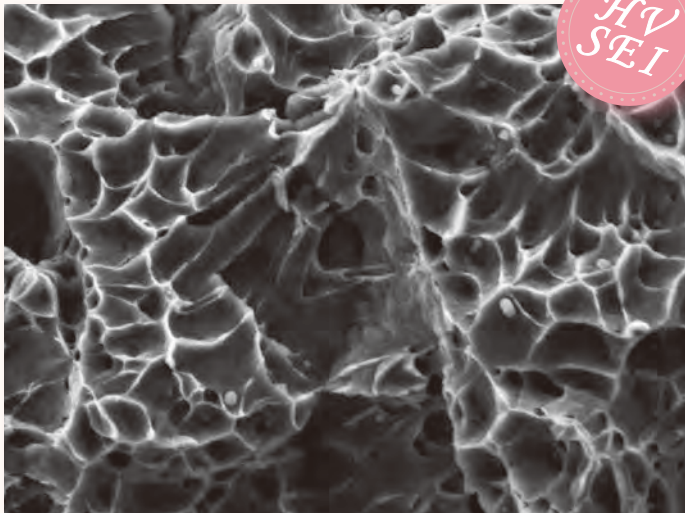

Sample: Metal fracture surface
Accelerating voltage 15 kV, magnification 5,000x

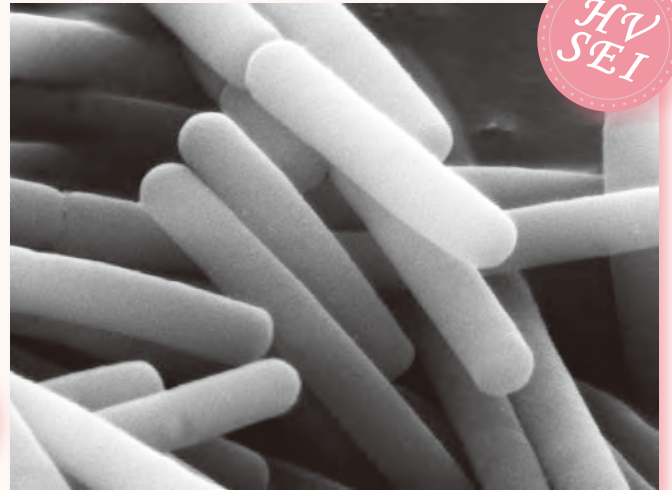

Sample: Yogurt culture
Accelerating voltage 15 kV, magnification 20,000x

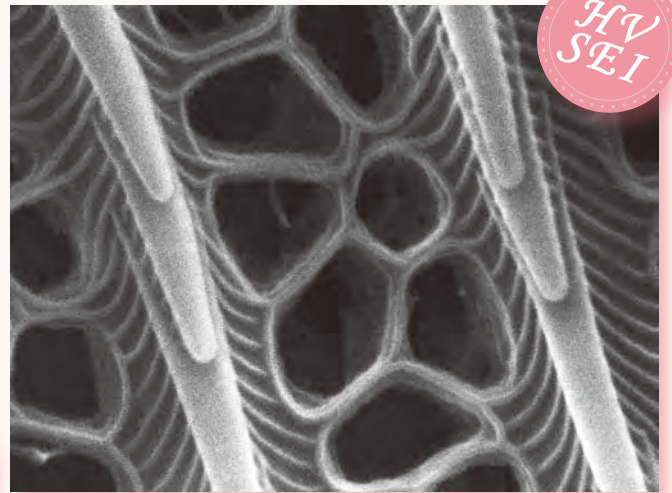

Sample: Butterfly scales
Accelerating voltage 15 kV, magnification 30,000x

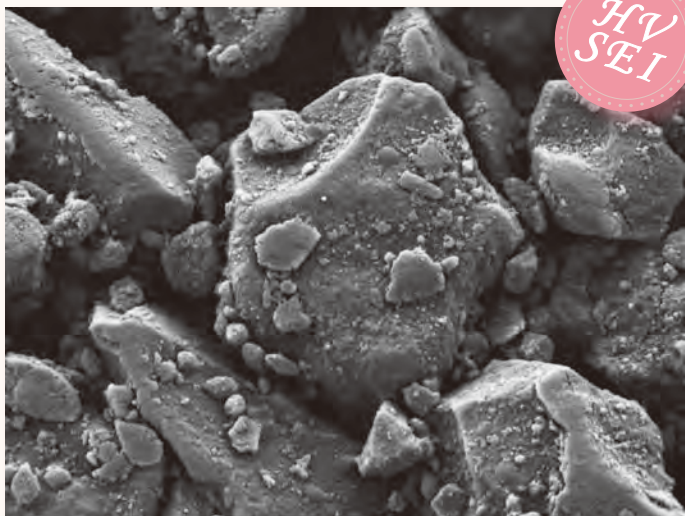

Sample: Coated paper
Accelerating voltage 5 kV, magnification 3,000x

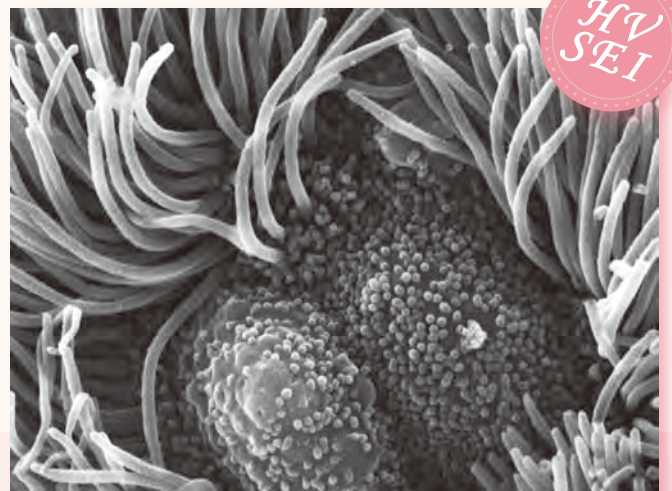

Sample: Mouse trachea
Accelerating voltage 15 kV, magnification 10,000x



Sample: Aluminum alloy 10 μm
 Backscattered electron image
 Accelerating voltage 10 kV, magnification 3,000 \times

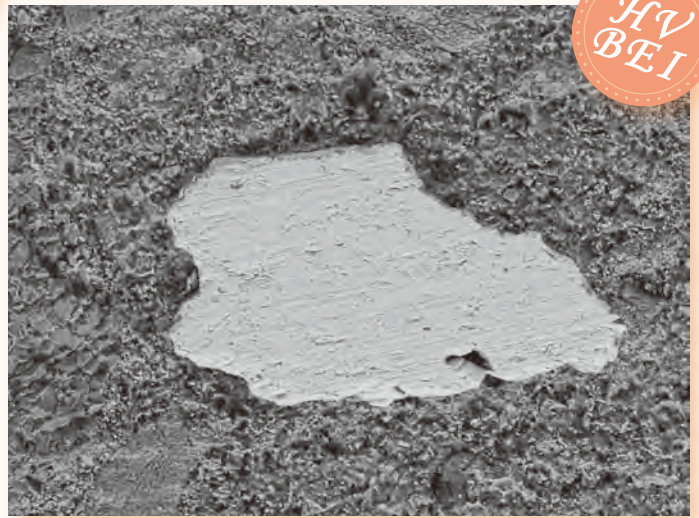

Sample: Concrete
 Backscattered electron image
 Accelerating voltage 15 kV, magnification 200 \times

Low vacuum mode

The Low Vacuum mode, a standard feature in NeoScope™, is designed to increase the pressure in the specimen chamber to neutralize the charges on the sample surface, allowing the operator to observe uncoated non conductive samples.

The Low Vacuum mode is also effective for samples containing a small amount of oil or water and gas-emitting samples that resist coating.

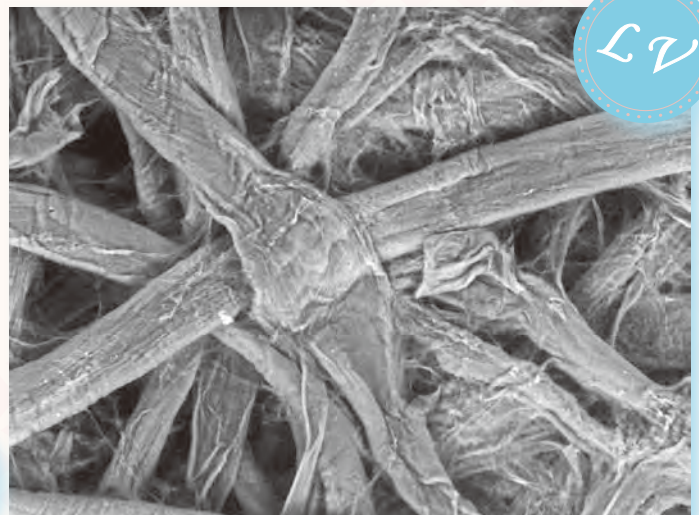

Sample: Filter paper
 Accelerating voltage 15 kV, magnification 540 \times

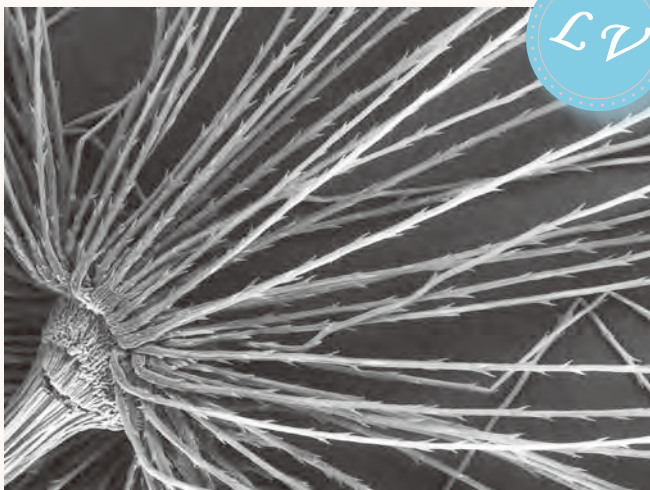

Sample: Dandelion puff
 Accelerating voltage 15 kV, magnification 80 \times

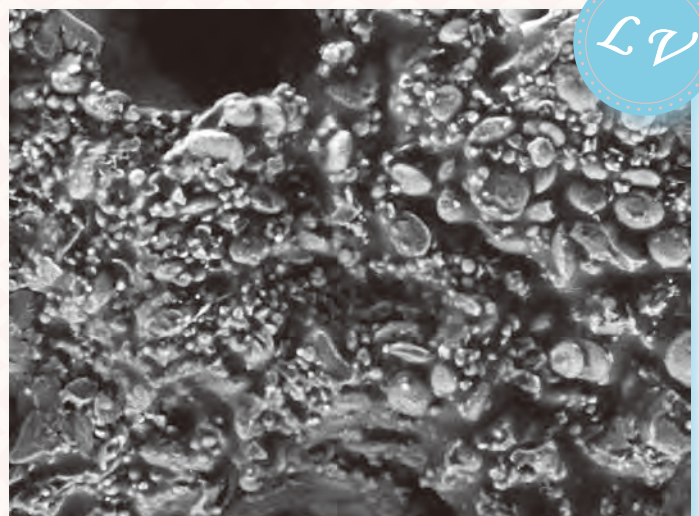

Sample: Cookie
 Accelerating voltage 15 kV, magnification 500 \times



02

Search and print

Search image window

The Search image window allows the operator to select and print image data. The window also allows the operator to restore the photographing conditions (accelerating voltage, filament current, probe current, etc.) for any image.

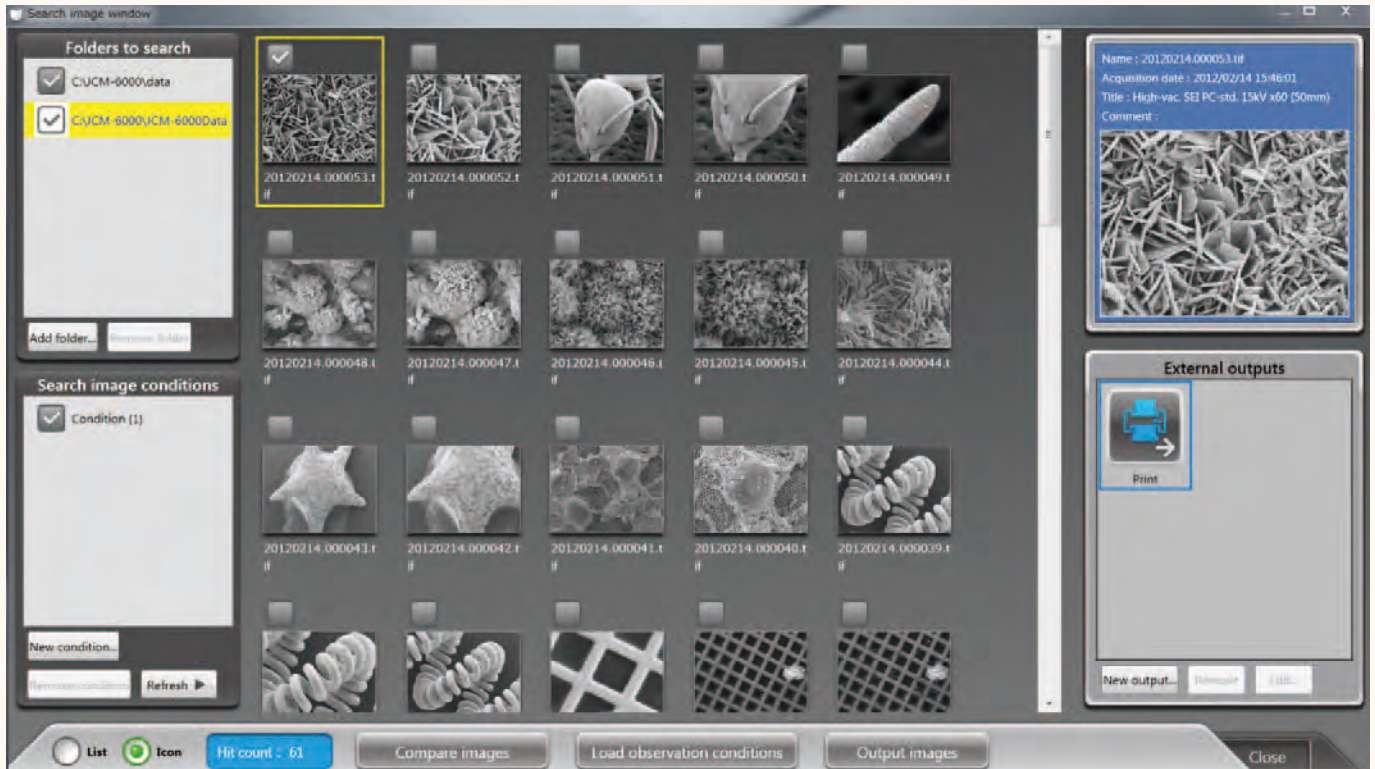

Search image window

Print

Checking a desired image and pressing the Output images button in the Search image window will display a preview image. If multiple images are selected, the system will automatically print 3 images per page.

Retrieve imaging conditions

NeoScope™ can retrieve the imaging conditions of any image that is saved in memory. The system will retrieve the data when an image is selected and the Load observation conditions button is pressed. It is a convenient feature for routine operation.

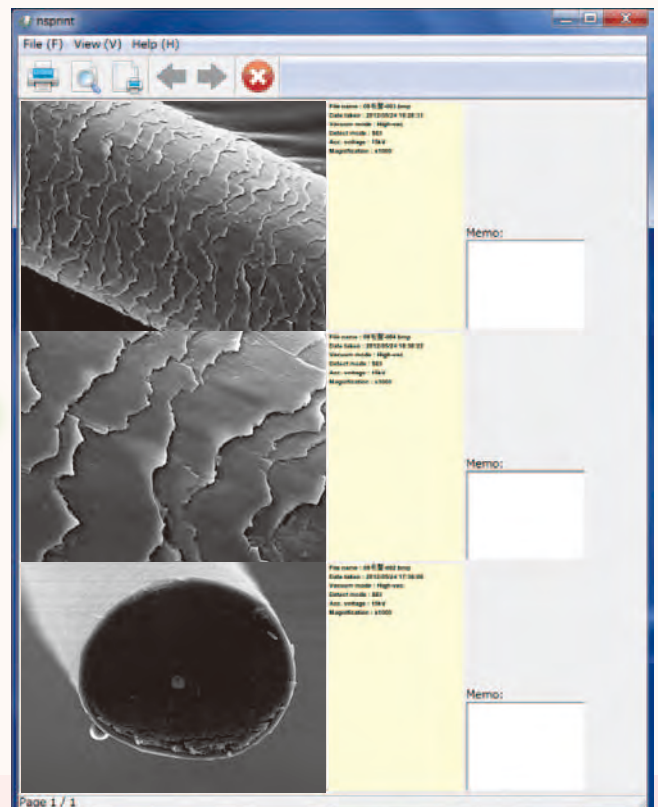

Sample: Human hair

Print view

03 Compare

Dual frame display

NeoScope™ can simultaneously display live and retrieved images. In the example below, a low magnification image is presented on the right while a magnified live image on the left. This allows the operator to compare a current image with another image retrieved from memory.

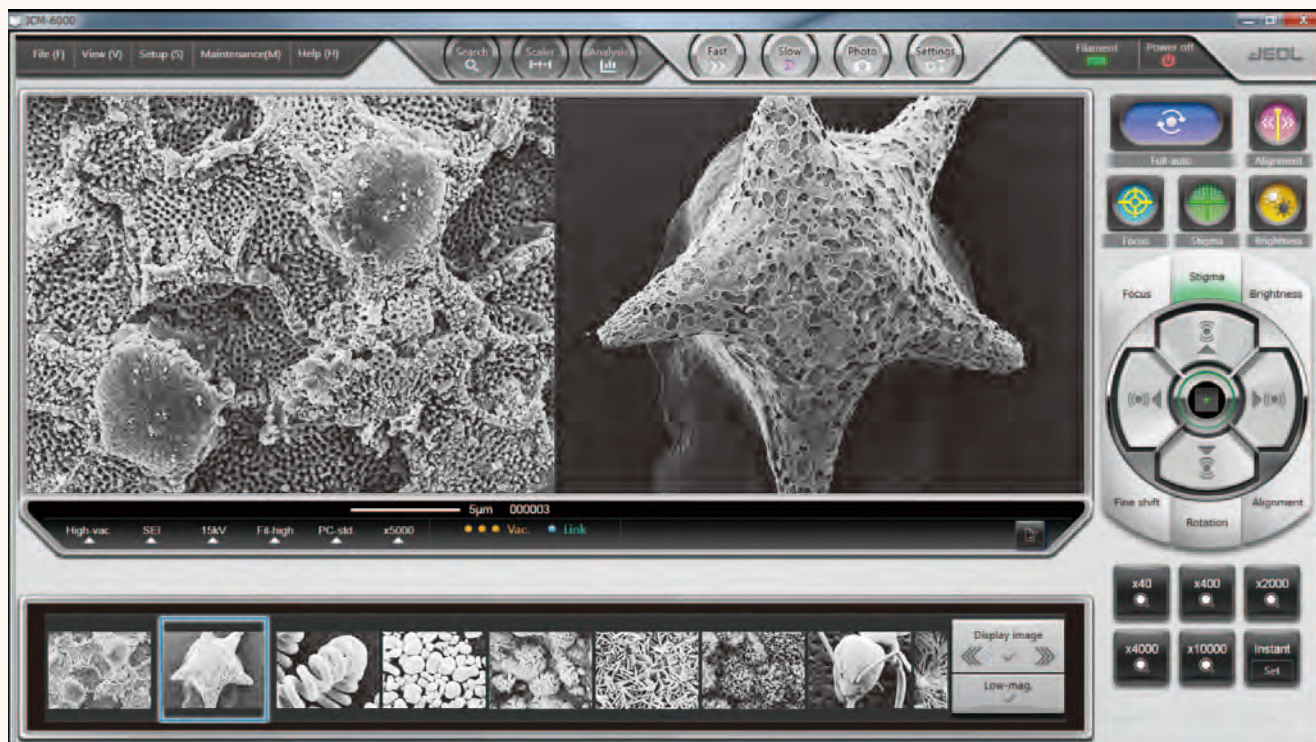

Sample: Star sand

04 Measure

EDS

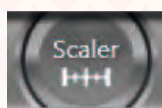

NeoScope™ incorporates a feature to measure the distance between 2 points. When the Scaler button is selected, the functions needed for measurement will be assigned to the auto control buttons. The measured results can be saved in image and CSV data files.



Sample: Metal particles

No.	Length	[unit]	Angle[deg]
1	5.79	um	44
2	5.47	um	12
3	6.12	um	89
4	5.54	um	41

05 Elemental analysis

EDS

Pressing the Analysis button will open the EDS view. EDS supports qualitative/quantitative analysis, point analysis, and mapping (elemental distribution).

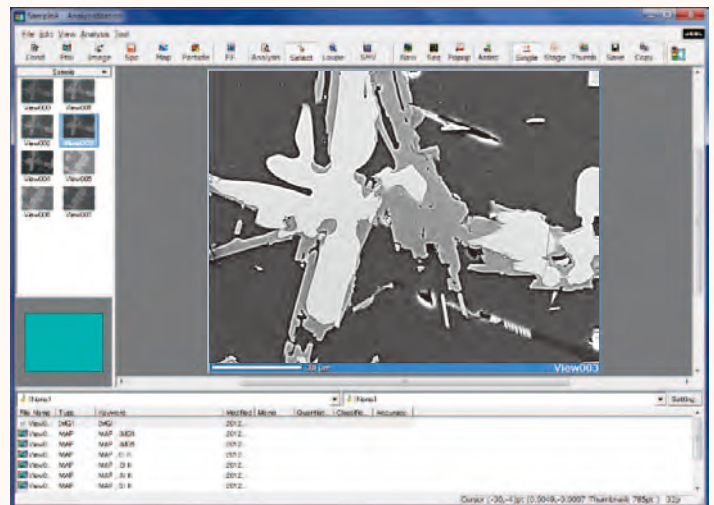

Qualitative/Quantitative analysis

Two buttons, Image and Spc, initiate analysis. Pressing the Quantitative button after data acquisition will display quantitative results.

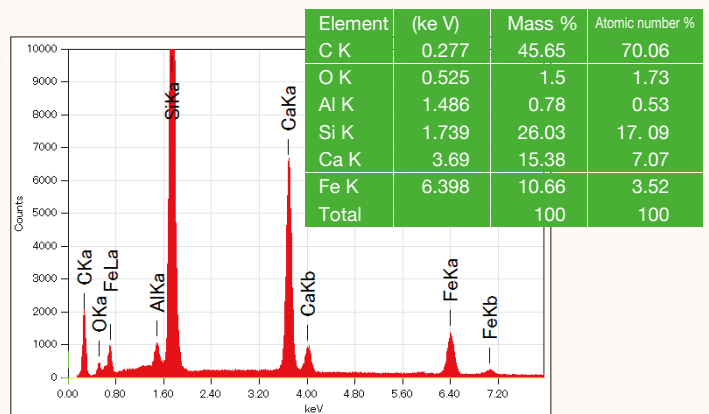
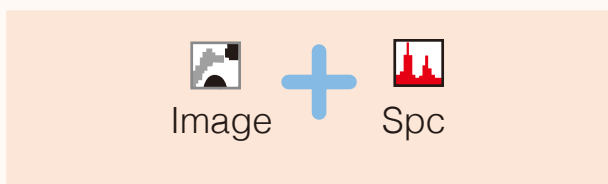

Mapping (elemental distribution)

Pressing the Map button will initiate elemental mapping of the image. The mapped results will show 2 dimensional distribution of the constituent elements.

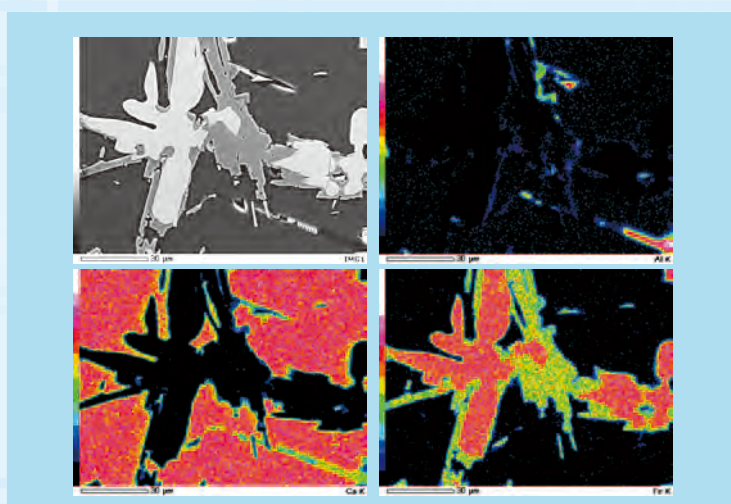

Using mapped results, the operator can:

- Create **quantitative maps** in color where each color represents the quantitative value of an element.
- **Reconstruct maps** of additional elements by data processing alone after analysis.
- Select a specific area on the map and extract the **spectrum**
- Overlap **elemental maps** and **identify** where the elements of interest exist in the area of view or how they are overlapped.

Powerful aid in complicated analysis

Analytical Assistance is one of the functions to help the operator navigate any data acquisition process, including mapping and line analysis.

When a type of analysis is selected from the Analytical Assistance view, the system will display a series of process steps needed for the analysis. The buttons shown in the view will guide the operator through any analytical procedure.

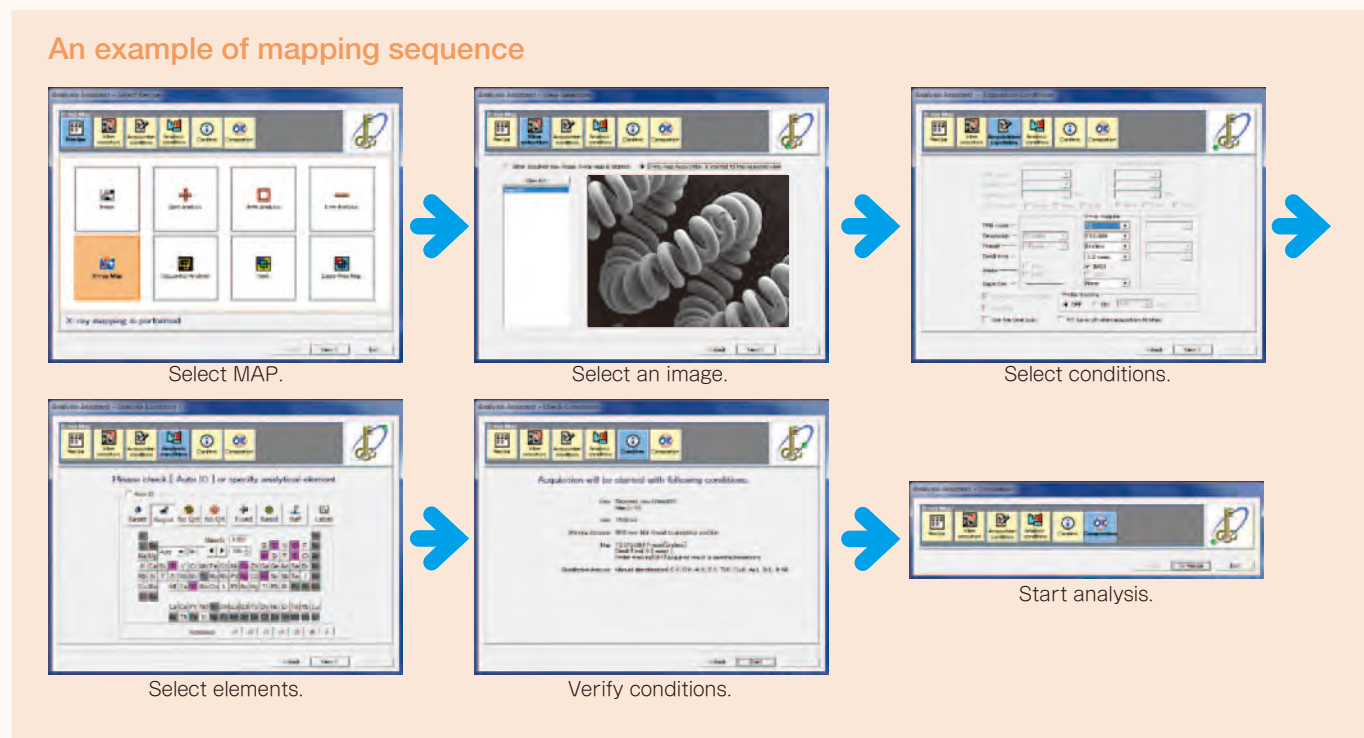

Point analysis

When multiple analytical points are selected on the image, the system will automatically analyze the elements on each point, and display spectral data. These spectra can be compared after the analysis is completed.

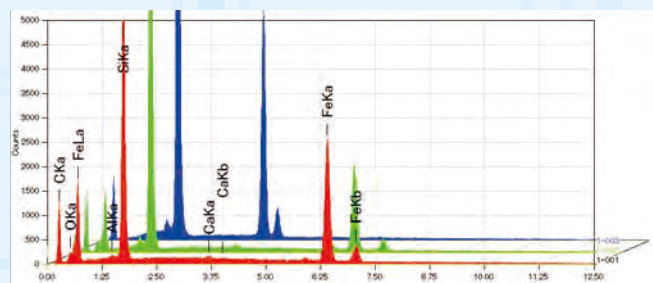

Line analysis

When a line is defined on the image, the system will begin measuring relative concentration changes in the elements on the line. The elements may be edited after the analysis is completed.

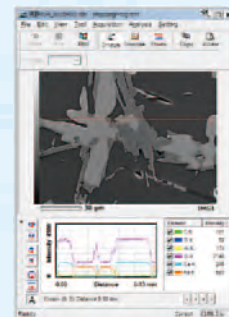

Probe tracking

Probe tracking is designed to maintain a stable analytical point for prolonged operation.

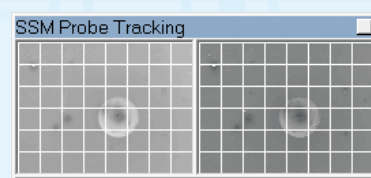

06

View at varying angles

OPTION

Tilting and Rotating Motor Drive Holder

The Tilting and rotating motor drive holder allows the operator to examine samples at different angles. Observation of a tilted sample results in 3 dimensional information of the sample. The tilt rotation motorized specimen holder is optional.



Tilt 0°

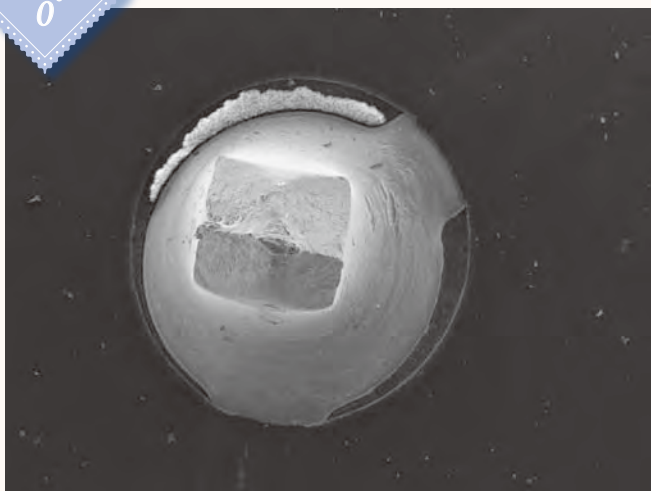

Sample: Substrate; magnification 45x

10 μm

Tilt 45°

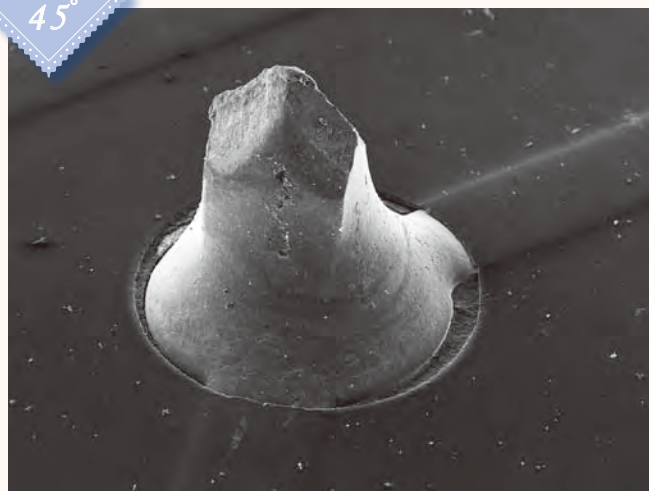

Sample: Substrate; magnification 45x

10 μm

Design your own operating environment

You can select any wallpaper for your GUI. Select one that you desire.



Sample: Spiderwort, uncoated, Low Vac mode

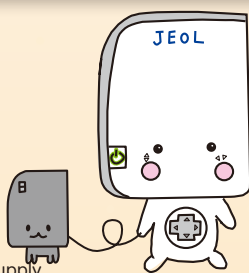

JCM-6000 character [Rokumarun]

Quick response

Startup

NeoScope™ will be ready for operation in 3 minutes after it is powered on.

Placing a sample and closing the door will automatically initiate the evacuation sequence.

An SEM image will be displayed when the evacuation is completed.



Selecting High Vacuum or Low Vacuum mode

A single touch on the panel can switch the mode between High Vacuum and Low Vacuum.

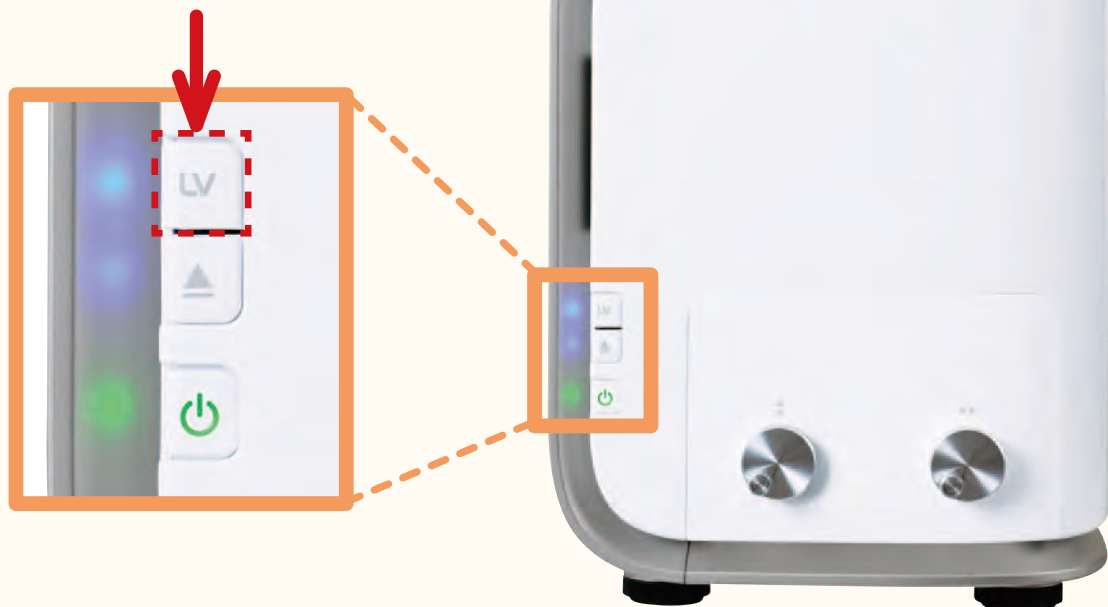

EDS analysis

NeoScope™ incorporates a JEOL proprietary dry SD detector. The detector is always ready for analysis during SEM imaging.

Easy maintenance

Filament

Changing filaments is simple and easy.

Unlike the conventional filament assembly that requires cleaning of the wehnelt, the electron gun in NeoScope™ uses a pre-centered cartridge filament that integrates a wehnelt. Since the cartridge is replaced as a unit, cleaning of the wehnelt or centering of the filament is not needed. The exchange process is quick and insures correct positioning of the filament.

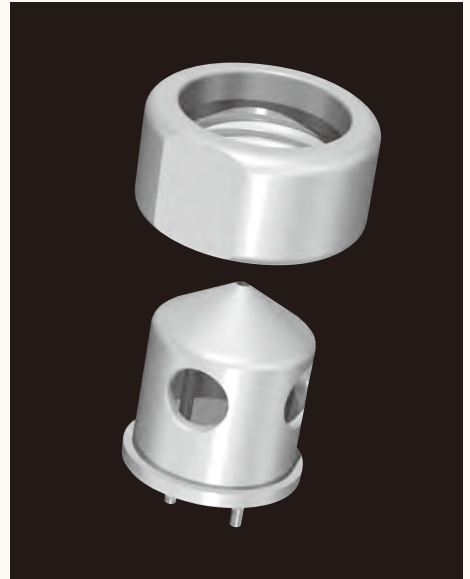

Filament-wehnelt integral grid

Auto gun alignment

Any new filament that is installed requires alignment to insure good image quality. This alignment process is fully automated in NeoScope™.

Peripherals

Coating device

Coating allows non conductive samples to be observed in the SEI mode under high vacuum. Comparing the SEI image with the low vacuum BEI image allows for closer examination of the fine surface structure.

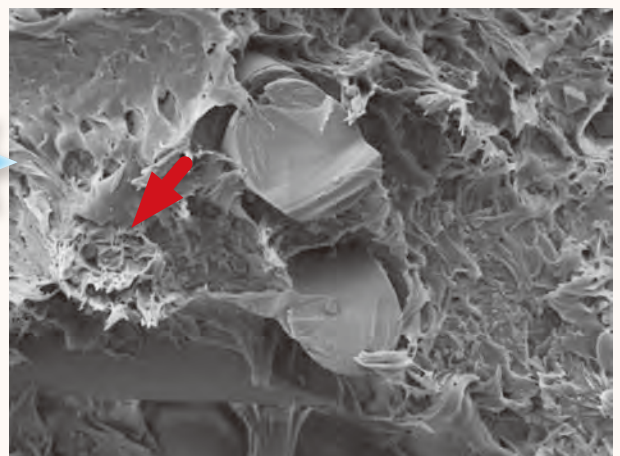
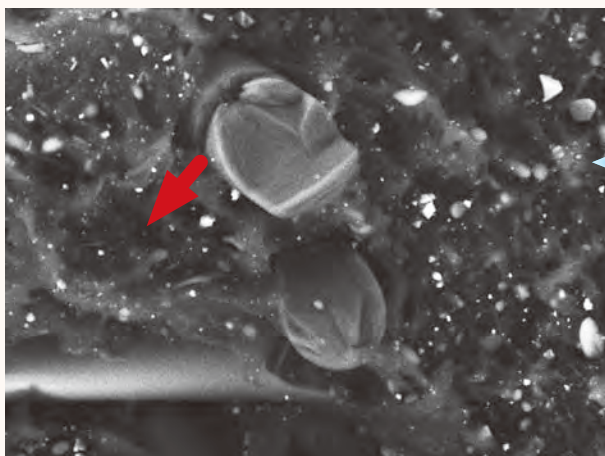

Sample: Resin fracture surface , Uncoated
Low Vacuum mode, backscattered electron image
Accelerating voltage: 15 kV; magnification: 1,500x

Sample: Resin fracture surface, gold coated
High Vacuum mode, secondary electron image
Accelerating voltage: 15 kV; magnification: 1,500x

Specifications

Magnification	Secondary electron image: ×10 to ×60,000 Backscattered electron image: ×10 to ×30,000 (when image size is 128 mm × 96 mm)
Imaging mode	Secondary electron image, backscattered electron image
Accelerating voltage	Secondary electron image; 5 kV, 10 kV, 15 kV (3 stages) Backscattered electron image; 10 kV, 15 kV (2 stages)
Electron gun	Small gun with cartridge filament integrating wehnelt
Bias current	Auto bias (linked to accelerating voltage and filament current)
Condenser lens	Two stage electromagnetic zoom condenser lens
Objective lens	Electromagnetic lens
Auto magnification correction	Magnification corrected with reference to sample height (7 mm, WD56 to 53 mm, WD10)
Preset magnification	6 levels, user programmable
Specimen stage	Manual control for X and Y: X: 35 mm, Y: 35 mm
Maximum sample size	70 mm diameter × 50 mm height
Specimen exchange	Draw-out mechanism
Image memory	One, 1,280 × 960 × 16 bits
Pixels	640 × 480, 1,280 × 960
Image processing	Pixel accumulation Image accumulation (recursible)
Automated functions	Filament, alignment, focus, stigmator, exposure
Metrology	Distance between 2 points, angles
File format	BMP, TIFF, JPEG
Computer	PC (desktop PC), OS Windows®7
Monitor	23 inch wide LCD monitor (touch panel)
Evacuation system	Fully automatic, TMP: 1, RP: 1

Optional accessories

- ◆ Tilt rotation motorized holder
Tilt: -15° to +45°; rotation: 360°
- ◆ EDS

Installation requirements

Power supply	Voltage: Single phase AC 100 V (120 V, 220 V, 240 V) 50/60 Hz, 700 VA (AC 100 V), 840 VA (AC 120 V), 880 VA (AC 220 V), 960 VA (AC 240 V), Fluctuation ±10% or less, with grounding
Installation Room	Room temperature 15 to 30°C Humidity 60% or less Operation table Sturdy table with a loading capacity of 100 kg or more
Weight	Main console: approximately 50 kg RP: approximately 9 kg Power supply box: approximately 10 kg
Base unit dimensions	(Width) (Depth) (Height) 325 mm × 490 mm × 430 mm

- * Specifications subject to change without notice.
- * The official name of Windows7 is Microsoft(R), Windows(R), Operating System.
- * Windows is a registered trademark of Microsoft Corp. in the U.S.
- * Other trademarks referenced in this catalog and marked with* are the property of our allied companies.

System composition

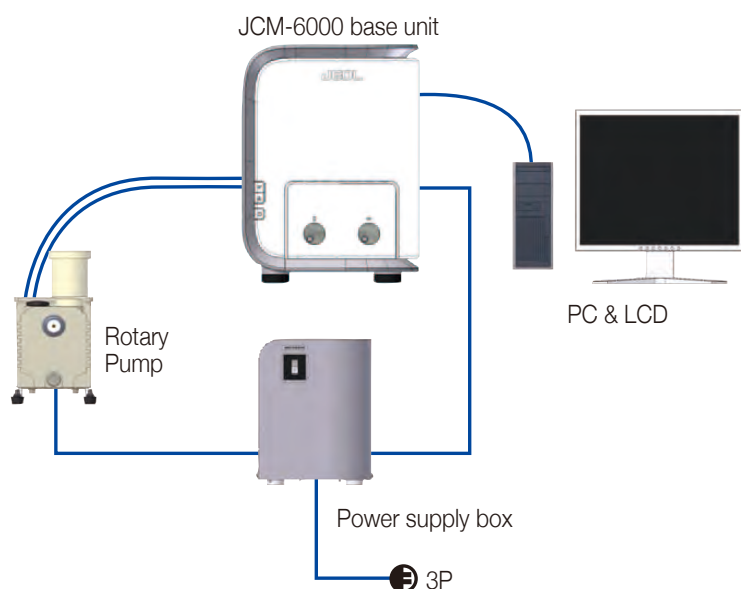

Index of samples	Page
Compound eye of an ant	3
Iron rust	4
Yogurt culture	6
Metal fracture surface	6
Butterfly scales	6
Coated paper	6
Mouse trachea	6
Aluminum alloy	7
Concrete	7
Filter paper (LV)	7
Dandelion puff (LV)	7
Cookie (LV)	7
Human hair	8
Star sand	9
Metal particles	9
Black ore (mineral)	10
Substrate	12
Spiderwort (LV)	12
Resin fracture surface (LV, HV)	14



Certain products in this brochure are controlled under the "Foreign Exchange and Foreign Trade Law" of Japan in compliance with international security export control. JEOL Ltd. must provide the Japanese Government with "End-user's Statement of Assurance" and "End-use Certificate" in order to obtain the export license needed for export from Japan. If the product to be exported is in this category, the end user will be asked to fill in these certificate forms.

JEOL JEOL Ltd.

1-2 Musashino 3-chome Akishima Tokyo 196-8558 Japan Sales Division Telephone:+81-42-528-3381 Facsimile:+81-42-528-3386 <http://www.jeol.com/>

ARGENTINA
COASIN S.A.C.IyF.
Virrey del Pino 4071,
1430 Buenos Aires
Argentina
Telephone: 54-11-4552-3185
Facsimile: 54-11-4555-3321

AUSTRALIA & NEW ZEALAND
JEOL(AUSTRALASIA) Pty.Ltd.
Suite 1, L2 18 Aquatic Drive
- Frenchs Forest NSW 2086
Australia
Telephone: 61-2-9451-3855
Facsimile: 61-2-9451-3822

AUSTRIA
JEOL (GERMANY) GmbH
Oskar-Von-Miller-Strasse 1a, 85386
Eching, Germany
Telephone: 49-8165-77346
Facsimile: 49-8165-77512

BANGLADESH
A.Q. CHOWDHURY SCIENCE & SYNERGY PVT. LTD.
House No. 12, Road No. 5A
Sector No. 11, Uttara Dhaka - 1230
Bangladesh
Telephone: 880-2-9807090, 8953450, 8953501
Facsimile: 880-2-8854428

BELGIUM
JEOL (EUROPE) B.V.
Planet II, Gebouw B
Leuvensesteenweg 542,
B-1930 Zaventem
Belgium
Telephone: 32-2-720-0560
Facsimile: 32-2-720-6134

BRAZIL
JEOL Brasil Instrumentos Cientificos Ltda.
Av. Jabaquara, 2958-5º andar-cj. 52
04046-500 Sao Paulo, SP
Brazil
Telephone: 55-11-5070 4000
Facsimile: 55-11-5070 4010

CANADA
JEOL CANADA, INC.
3275 Premier Rue #8,
St-Hubert, Quebec J5Y 8Y6, Canada
Telephone: 1-450-676-8776
Facsimile: 1-450-676-6694

CHILE
ARQUIMED INNOVATION
Arturo Prat 828,
Santiago, Chile
Telephone: 56-2-634-6266
Facsimile: 56-2-634-4633

CHINA
JEOL(BEIJING) CO., LTD.
Room B1010/1110, Wintong New World Plaza No. 2
Fuchengmenwai Street, Xicheng District,
Beijing 100037, P.R.China
Telephone: 86-10-6804-6321
Facsimile: 86-10-6804-6324

JEOL (BEIJING) CO., LTD., SHANGHAI BRANCH
Room 1505/1506, Nol 300Xi Kang Road,
Jing an Dist., Shanghai, 200040, China
Telephone: 86-21-6248-4868/4487/4537/4404
Facsimile: 86-21-6248-4075

JEOL (BEIJING) CO., LTD., GUANG ZHOU BRANCH
N1601, World Trade Center Building,
371-375, Huan Shi Road East, Guang Zhou,
Guangdong Prov., 510095, P.R.China
Telephone: 86-20-8779-7848
Facsimile: 86-20-8778-4268

JEOL (BEIJING) CO., LTD., WUHAN BRANCH
Room A2117, Zhongshang Plaza Office Bldg.,
No. 7 Zhongnan Road, Wuhan,
Hubei, 430071, P.R.China
Telephone: 86-27-8713-2567
Facsimile: 86-27-8713-2567

JEOL LTD. (BEIJING) CO., LTD., CHENGDU BRANCH
1807A Zongfu Building,
NO. 35 Zhongfu Road, Chengdu, Sichuan, 610016
P.R. China
Telephone: 86-28-86622554
Facsimile: 86-28-86622564

EGYPT
JEOL SERVICE BUREAU
3rd Fl. Nile Center Bldg., Nawal Street,
Dokki, (Cairo), Egypt
Telephone: 20-2-3335-7280
Facsimile: 20-2-3338-1186

FRANCE
JEOL (EUROPE) SAS
Espace Claude Monet, 1 Allée de Giverny
78290, Croissy-sur-Seine, France
Telephone: 33-13015-3737
Facsimile: 33-13015-3747

GERMANY
JEOL (GERMANY) GmbH
Oskar-Von-Miller-Strasse 1a, 85386
Eching, Germany
Telephone: 49-8165-77346
Facsimile: 49-8165-77512

GREAT BRITAIN & IRELAND
JEOL (U.K.) LTD.
JEOL House, Silver Court, Watchmead,
Welwyn Garden City, Herts AL7 1LT, U.K.
Telephone: 44-1707-377117
Facsimile: 44-1707-373254

GREECE
N. ASTERIASIS S.A.
56-58,S. Trikoupis Str, P.O. Box 26140
GR-10022, Athens, Greece
Telephone: 30-1-823-5383
Facsimile: 30-1-823-9567

HONG KONG
FARMING LTD.
Unit No. 1009, 10/F, Prosperity
Millennia Plaza, 663 King's Road
North Point, Hong Kong
Telephone: 852-2815-7299
Facsimile: 852-2581-4635

INDIA
JEOL INDIA Pvt. Ltd.
Elegance Tower, Level 2, 212B
Old Mathura Road, Jasola Business District Center,
Near Apollo Hospital Jasola,
New Delhi 110 025, India
Telephone: 91-11-46472-2578
Facsimile: 91-11-4060-1235

BLUE STAR LTD. (HQ: Mumbai)
Analytical Instruments Department,
Sahas' 41/2 Veer Savarkar Marg
Prabhadery Mumbai 400 025, India
Telephone: 91-22-6666-4000
Facsimile: 91-22-6666-4001

BLUE STAR LTD. (Delhi)
Analytical Instruments Department,
E-44/12 Okhla Industrial Area,
Phase-II, New Delhi 110 020, India
Telephone: 91-11-4149-4000
Facsimile: 91-11-4149-4005

BLUE STAR LTD. (Calcutta)
Analytical Instruments Department,
7, Hare Street Calcutta 700 001, India
Telephone: 91-33-2213-4133
Facsimile: 91-33-2213-4102

BLUE STAR LTD. (Chennai)
Analytical Instruments Department,
No. 46, Garuda Building,
Cathedral Road, Chennai 600 086, India
Telephone: 91-44-4244-4000
Facsimile: 91-44-4244-4190

INDONESIA
PT. TEKNOLABIndo Penta Perkasa
Komplek Gading Bukit Indah Blok I/11
Jl. Bukit Gading Raya Kelapa Gading Permai,
Jakarta 14240, Indonesia
Telephone: 62-21-45847057/58/59
Facsimile: 62-21-45842729

ITALY
JEOL (ITALIA) S.p.A.
Centro Direzionale Green Office
Via dei Tulipani, 1
20090 Pieve Emanuele (MI) Italy
Telephone: 39-02-9041431
Facsimile: 39-02-90414343

KOREA
JEOL KOREA LTD.
Dongwoo Bldg. 7F, 1443, Yangjae Daero,
Gangdong-Gu, Seoul, 134-010, Korea
Telephone: 82-2-511-5501
Facsimile: 82-2-511-2635

KUWAIT
Ashraf & CO. Ltd. W.L.L.
P.O.Box 3555 Safat 13036, Kuwait
Telephone: 965-1805151
Facsimile: 965-24335373

MALAYSIA
JEOL(MALAYSIA) SDN.BHD.(359011-M)
205, Block A, Mezzanine Floor,
Kelana Business Center,
97, Jalan SS 7/2, Kelana Jaya,
47301 Petaling Jaya, Selangor, Malaysia
Telephone: 60-3-7492-7722
Facsimile: 60-3-7492-7723

MEXICO
JEOL DE MEXICO S.A. DE C.V.
Arkansas 11 Piso 2
Colonia Napoles
Delegacion Benito Juarez, C.P. 03810
Mexico D.F., Mexico
Telephone: 52-5-55-211-4511
Facsimile: 52-5-55-211-0720

PAKISTAN (Karachi)
ANALYTICAL MEASURING SYSTEM (PVT) LTD.(AMS LTD.)
14-C Main Sehar Commercial Avenue Lane 4,
Khayaban-e-Sehar,
D.H.A-VII, Karachi-75500, Pakistan
Telephone: 92-21-35345581/35340747/35346057-8
Facsimile: 92-21-35345582

PANAMA
PROMED S.A.
Parque Industrial Costa del Este
Urbanizaciones Costa del Este
Apartado 0816-01755, Panama, Panama
Telephone: 507-303-3100
Facsimile: 507-303-3115

PHILIPPINES
PHILAB INDUSTRIES INC.
7487 Bagtikan Street, SAV Makati,
1203 Metro, Manila Philippines
Telephone: 63-2-896-7218
Facsimile: 63-2-897-7732

PORTUGAL
Izasa Portugal Lda.
R. do Proletariado, 1
2790-138 CARNAXIDE, Portugal
Telephone: 351-21-424-73-00
Facsimile: 351-21-418-60-20

RUSSIA
JEOL (RUS) LLC.
Krasnoyarskaya Street, 16,
Bl. 2, 127473, Moscow,
Russian Federation
Telephone: 7-495-748-7791/7792
Facsimile: 7-495-748-7793

SAUDI ARABIA
ABDULREHMAN ALGOSAIBI G.T.C. (Riyadh)
King Abdulaziz Avenue,
P.O. Box 215, Riyadh 11411, Saudi Arabia
Telephone: 966-1-479-3000
Facsimile: 966-1-477-1374

SCANDINAVIA
SWEDEN
JEOL (Skandinaviska)AB
Hammarbacken 6A, Box 716, 191 27 Sollentuna
Sweden
Telephone: 46-8-28-2800
Facsimile: 46-8-29-1647

SERVICE & INFORMATION OFFICE
NORWAY
JEOL (Skandinaviska)AB
Lorenvangen 23, 0580 Oslo, NORWAY
Telephone: 47-2-2-64-7930
Facsimile: 47-2-2-65-0619

FINLAND
JEOL (Skandinaviska)AB
Yakapuunkuja 2, FIN-02360 Espoo, Finland
Telephone: 358-9-8129-0350
Facsimile: 358-9-8129-0351

SINGAPORE
JEOL ASIA PTE. LTD.
2 Corporation Road #01-12 Corporation Place
Singapore 618494
Telephone: 65-6565-9989
Facsimile: 65-6565-7552

SOUTH AFRICA
ADI Scientific (Pty) Ltd.
370 Angus Crescent,
Northlands Business Park, 29 Newmarket Road
Northriding, Randburg, Republic of South Africa
Telephone: 27-11-462-1363
Facsimile: 27-11-462-1466

SPAIN
IZASA, S.A.
Argoneses, 13, 28100 Alcobendas,
(Poligono Industrial), Madrid, Spain
Telephone: 34-91-663-0500
Facsimile: 34-91-663-0545

SWITZERLAND
JEOL (GERMANY) GmbH
Oskar-Von-Miller Strasse 1,
85386 Eching, Germany
Telephone: 49-8165-77346
Facsimile: 49-8165-77512

TAIWAN
For EO Products
JIE DONG CO., LTD.
7F, 112, Chung Hsiao East Road,
Section 1, Taipei, Taiwan 10023
Republic of China
Telephone: 886-2-2395-2978
Facsimile: 886-2-2322-4655

For Mass Spectrometer Products:
Mass Solutions Technology Co., Ltd.
5F, No.79, Sec. 1, Xintai 5th Rd
Xizhi Dist., New Taipei City 221, Taiwan
Republic of China
Telephone: 886-2-2698-9511
Facsimile: 886-2-2698-9512

For Semiconductor Products:
JEOL TAIWAN SEMICONDUCTORS LTD.
11F-1, No. 346, Pei-Da Road, Hsin-Chu City 300,
Tawan, Republic of China
Telephone: 886-3-523-8490
Facsimile: 886-3-523-8503

THAILAND
BECTHAI BANGKOK EQUIPMENT & CHEMICAL CO., Ltd.
300 Phaholyothin Rd. Phayathai, Bangkok 10400,
Thailand
Telephone: 66-2-615-2929
Facsimile: 66-2-615-2350/2351

THE NETHERLANDS
JEOL (EUROPE) B.V.
Lireweg 4, NL-2153 PH Nieuw-Vennep,
The Netherlands
Telephone: 31-252-623500
Facsimile: 31-252-623501

TURKEY
TEKSER A.S.
Kavisdagi, Inonu Mah.Kartal Cad. No:55/3
34755 Atasehir / Istanbul, Turkey
Telephone: 90-216-5736470
Facsimile: 90-216-5736475

UAE
MRS Group Dubai
P.O.Box: 171612,
Rashid Abdulla Al Noami Building
Suite No: 306, Damascus Street,
AI Qusais-3, Dubai, U.A.E.
Telephone: 971-4-2581141
Facsimile: 971-4-2581151

JEOL Gulf
P.O.Box: 171612,
Rashid Abdulla Al Noami Building
Suite No: 306, Damascus Street,
AI Qusais-3, Dubai, U.A.E.
Telephone: 971-553964219(mobile)

USA
JEOL USA, INC.
11 Dearborn Road, Peabody, MA 01960, U.S.A.
Telephone: 1-978-535-5900
Facsimile: 1-978-536-2205/2206

JEOL USA, INC. WEST OFFICE
5653 Stoneridge Drive Suite #110
Pleasanton, CA 94588, U.S.A.
Telephone: 1-925-737-1740
Facsimile: 1-925-737-1749

VENEZUELA
GOMSA Service and Supply C.A.
Urbanizacion Montalban III
- Residencias Don Andres - Piso 7 - Apartamento 74
Avenida 3, entre calles 7 y 6
Montalban, Caracas, Venezuela
Telephone: 58-212-443-4342
Facsimile: 58-212-443-4342

VIETNAM
TECHNICAL MATERIALS AND RESOURCES
IMPORT-EXPORT JOINT STOCK COMPANY(REXCO)
Hanoi Branch,
No. 13-Lot 12 Trung Yen, Trung Hoa Street, Cau Giay Dist,
Hanoi, Vietnam
Telephone: 84-4-562-0516,17/562-0535
Facsimile: 84-4-853-2511